

**SDH/PDH/ATM ANALYZER
MP1552B**

For General Testing of PDH, SDH, ATM, and SONET Network

NEW



**GPIB
OPTION**

The MP1552B is a portable analyzer designed specifically for troubleshooting the construction and maintenance of SDH, PDH, and ATM networks, as well as for evaluating equipment for these networks. Various systems can be configured using plug-in units, according to the application.

The MP1552B has two basic slots and three application slots. CEPT, North American, and Japanese systems can be analyzed by installing interface units into the basic slots. In addition, when two interface units are installed at the same time, the analyzer can perform international mapping. ATM and Jitter/Wander tests can be performed by installing application plug-in units in the three other slots.

The analyzer has a built-in printer and 3.5 inch floppy disk drive as standard. The measurement results can be printed out or the data can be saved directly to the FDD for reading with an external personal computer. Furthermore, the FDD can be used to upgrade the analyzer firmware, making compliance with the latest ITU-T specifications easy.

The pop-up menus permit item selection at a glance, so even a novice can use the MP1552B immediately. In addition, the auto set-up function enables automatic line mapping and easy line evaluation.

Feature

- For SDH, PDH, and ATM network construction and maintenance

Performance and functions

- PDH/SDH full analysis functions

An optical power meter is built-in, permitting optical power measurement while measuring alarms and errors, with no need to switch optical fiber connections.

Any SOH (1 byte) or K1/K2 byte can be captured in 64 frames for both error/alarm analysis and APS operation confirmation.

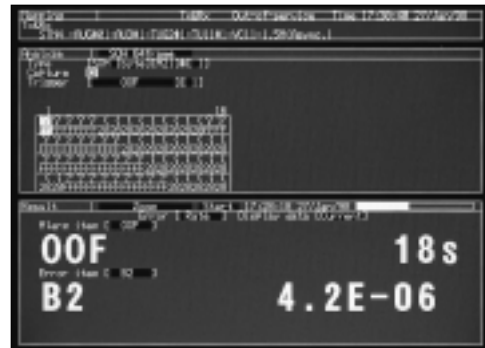

Measured errors/alarms can be displayed as a graph, and 1 second, 1 minute, 15 minutes, and 60 minutes can be set as the bar graph time units.

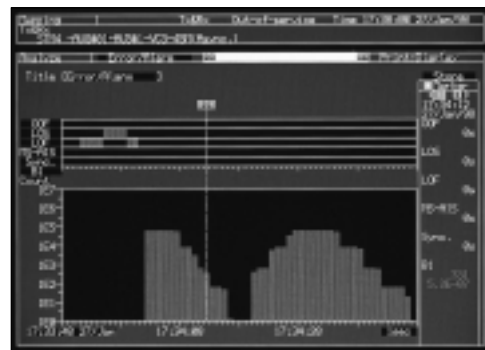

• Jitter and wander automatic measurement

Jitter tolerance, jitter transfer, and jitter frequency can all be measured automatically. And since the data can be saved to floppy disk in text format, data management is made simple by using a personal computer.

Masks conforming to ITU-T Rec. G.823/G.824/G.825/G.958 standards are provided as preset data. Measurement is performed simply by pressing the start key. Furthermore, the operator can also set any other mask as necessary.

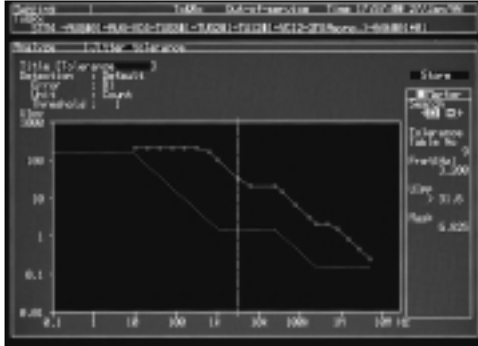

• Simultaneous monitoring of 1023 channel cells and non-conforming cells

The VPI/VCI for 1023 channels can be detected automatically, and the presence/absence of alarms, ATM cell count, and non-conforming cell count can be displayed graphically for easy comparison of line channel traffic.

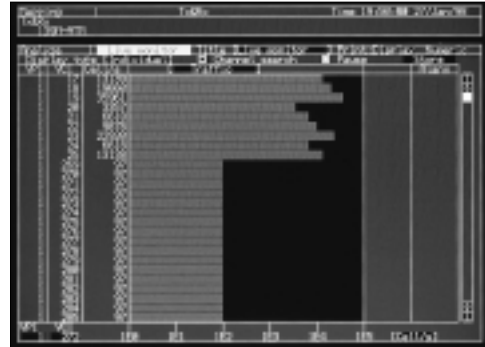

Specifications

• MP0121A 2/8/34/139/156M*1 Unit

Bit rate	2.048, 8.448, 34.368, 139.264 Mb/s
Level/waveform	Conforms to ITU-T G.703 (with 20 dB monitoring point)
Connectors	BNC (75 Ω, unbalanced), 3-pin Siemens (120 Ω, balanced) 2.048 Mb/s: HDB3 (balanced/unbalanced) 8.448, 34.368 Mb/s: HDB3 (unbalanced) 139.264 Mb/s: CMI (unbalanced)
Clock	Internal (accuracy: ±7 ppm, jitter unit not installed), external (ECL [AC] 50 Ω), received signal
Frame format	Unframed: 2, 8, 34, 139 Mb/s Framed: 2 Mb/s (with/without CRC-4 at channels 30/31, G.704), 8 Mb/s (G.742), 34 Mb/s (G.751), 139 Mb/s (G.751), MUX/DEMUX (Option 06)
Test patterns	PRBS: 2 ¹¹ - 1, 2 ¹⁵ - 1, 2 ²⁰ - 1, 2 ²³ - 1 (O.151) Word: 16-bit programmable, all 0, all 1
Error addition	Bit (all, test pattern), code, E-bit Timing: Single, rate (1E-3, 1E-4, 1E-5, 1E-6, 1E-7) FAS: n in 16 (n: 1 to 4), all
Alarm addition	LOS, LOF, AIS, RDI, RDI (MF) Timing: All
Measurements	Mode: Single, repeat, manual In-service Errors: Frame, code, CRC-4, E-bit Alarms: Power-fail, LOS, AIS, LOF, MF loss, RDI, RDI (MF) Error performance: G.821 (inc. Annex D), M.2100, G.826 Out-of-service Errors: Frame, code, CRC-4, E-bit, bit Alarms: Power-fail, LOS, AIS, LOF, MF loss, RDI, RDI (MF), sync loss Error performance: G.821 (inc. Annex D), M.2100, G.826
LEDs	LOS, AIS, LOF, MF loss, RDI, RDI (MF), sync loss, errors
Monitor	Frame word
Trouble search	Auto search for errors/alarms in all measured channels
Delay measurement	0 to 1 s
Auxiliary interface	Clock sync output, frame sync output, error output

*1: Built-in 156M CMI (electrical) interface

• MP0122A 1.5/45/52M*1 Unit, MP0122B 1.5/45/52/52M*2 (1.31) Unit

Bit rate	1.544, 44.736 Mb/s
Level/waveform	1.544 Mb/s: ANSI T1.102 (with 20 dB monitoring point), 0/655 ft 44.736 Mb/s: ANSI T1.102 (with 20 dB monitoring point), 0/450/900 ft
Connectors	BNC (75 Ω, unbalanced), Bantam (100 Ω, balanced) 1.544 Mb/s: AMI/B8ZS (balanced), 44.736 Mb/s: B3ZS (unbalanced)
Clock	Internal (accuracy: ±7 ppm, jitter unit not installed), external (ECL [AC] 50 Ω) received signal

Continued on next page

Frame format	Unframed: 1.5, 45 Mb/s Framed: 1.5 Mb/s (D4, ESF, Japan ESF*3), 45 Mb/s (M13, C-bit), MUX/DEMUX (Option 07)
Test patterns	PRBS: 2 ¹¹ - 1, 2 ¹⁵ - 1, 2 ²⁰ - 1 (zero suppress), 2 ²⁰ - 1, 2 ²³ - 1 (O.151) Word: 16-bit program, all 0, all 1, 3 in 24 (1.5 Mb/s)
Error addition	Bit (all, test pattern), code, parity, CRC-6, C-bit, REI Timing: Single, rate (1E-3, 1E-4, 1E-5, 1E-6, 1E-7) FAS (45 Mb/s): n in 16 (n: 1 to 4), all
X-bit setting	00, 01, 10, 11
Alarm addition	LOS, LOF, AIS, RDI Timing: All
Measurements	Mode: Single, repeat, manual In-service Errors: FAS, code, parity, CRC-6, C-bit, REI Alarms: Power-fail, LOS, AIS, LOF, RDI Error performance: G.821 (inc. Annex D), M.2100, G.826 Out-of-service Errors: FAS, code, parity, CRC-6, C-bit, REI, bit Alarms: Power-fail, LOS, AIS, LOF, RDI, sync loss Error performance: G.821 (inc. Annex D), M.2100, G.826
LEDs	LOS, LOF, AIS, RDI, sync loss, errors
Trouble search	Auto search for errors/alarms in all measured channels
Delay measurement	0 to 1 s
Auxiliary interface	Clock sync output, frame sync output, error output

- *1: Built-in 52M B3ZS (electrical) interface
- *2: Built-in 52M B3ZS (electrical) and optical interfaces
- *3: Built-in Option 17 (1.5M Japan ESF)

● 52/156/622/2488M

Bit rate	51.840, 155.520, 622.080, 2488.320 Mb/s
Level/waveform	52M (electrical: B3ZS)*1: ANSI T1.102, 0/450 ft 52M (optical): As per MP0122B optical interface specifications 156M (electrical: CMI)*2: ITU-T G.703 156M (optical): As per interface unit specifications 622M (electrical, optical): As per interface unit specifications 2488M (electrical, optical): As per 2.5G unit specifications
Clock	Internal (accuracy: ±3.5 ppm, jitter unit not installed), lock (2/1.5M, 64k*3), external (ECL [AC] 50 Ω), received signal
Mapping	See Figs. 1 to 3.
Through	Loop through (bit error insertion possible)
Test patterns	PRBS: 2 ¹¹ - 1, 2 ¹⁵ - 1, 2 ²⁰ - 1 (zero suppress, MP0122A/B installed), 2 ²⁰ - 1, 2 ²³ - 1 (O.151) Word: 16-bit programmable, all 0, all 1
Error addition	Bit (all, test pattern), FAS, B1, B2, B3, BIP-2, MS-REI, HP-REI, LP-REI Timing: Single, rate (1E-3, 1E-4, 1E-5, 1E-6, 1E-7, 1E-8, 1E-9) FAS: Alternative (normal frame: 1 to 15, error frame: 0 to 15)
Alarm addition	LOS, LOF, MS-AIS, MS-RDI, AU-AIS, AU-LOP, HP-RDI, TU-AIS, TU-LOP, TU-LOM, LP-RDI, LP-RFI Timing: All
Measurements	Mode: Single, repeat, manual In-service Errors: B1, B2, B3, BIP-2, MS-REI, HP-REI, LP-REI Alarms: Power-fail, LOS, LOF, OOF, MS-AIS, MS-RDI, AU-AIS, AU-LOP, HP-RDI, TU-AIS, TU-LOP, TU-LOM, LP-RDI, LP-RFI Error performance: G.826, M.2101 Out-of-service Errors: B1, B2, B3, BIP-2, MS-REI, HP-REI, LP-REI, bit Alarms: Power-fail, LOS, LOF, OOF, MS-AIS, MS-RDI, AU-AIS, AU-LOP, HP-RDI, TU-AIS, TU-LOP, TU-LOM, LP-RDI, LP-RFI, sync loss Error performance: G.826, M.2101
LEDs	LOS, LOF, OOF, MS-AIS, MS-RDI, AU-AIS, AU-LOP, HP-RDI, TU-AIS, TU-LOP, TU-LOM, LP-RDI, LP-RFI, sync loss, error
Justification	AU pointer, TU pointer, C, C1/C2 Measurement: NDF, +PJC, -PJC, 3 times consecutive
Monitor	SOH, POH, K1/K2, pointer, path trace (TIM alarms detectable)
Pointer sequence	Signal of opposite polarity, regular with double, regular with missing, double of opposite polarity 87-3/26-1 (normal, add, cancel), continuous pattern (normal, add, cancel)
SOH 64-frame	K1/K2, any 1 byte
Trouble search	Auto search for errors/alarms in all measured channels
Delay measurement	0 to 1 s
Auxiliary interface	Clock sync output, frame sync output, DCC interface (V.11)

- *1: Mounted MP0122A/B
- *2: Mounted MP0121A
- *3: Built-in Option 16 (64k lock)

• General

Printer	Internal, external
Internal memory	Measurement settings memory: 10, graphics memory: 15
Others	FDD, RS-232C (Option 01), GPIB (Option 02), Ethernet (Option 03)* ¹ , video output (Option 15)* ² , buzzer, clock
EMC	EN55011: 1991, Group 1, Class A EN50082-1: 1992 Harmonic current emissions: EN61000-3-2 (1995)
Safety	EN61010-1: 1993 (Installation Category II, Pollution Degree II)
Dimensions and mass	320 (W) x 177 (H) x 350 (D) mm, 10 kg approx. (excluding plug-in units and options)
Power	100 to 240 Vac, 47.5 to 63 Hz, ≤300 VA
Temperature	0° to +40°C

*1: Change each of the RS-232C, GPIB, and video output boards and use them.

*2: The video output, RS-232C, and GPIB options cannot all be used simultaneously. Only the video output + RS-232C, or video output + GPIB, or RS-232C + GPIB board combinations support simultaneous use, so change the board combinations according to the purpose.

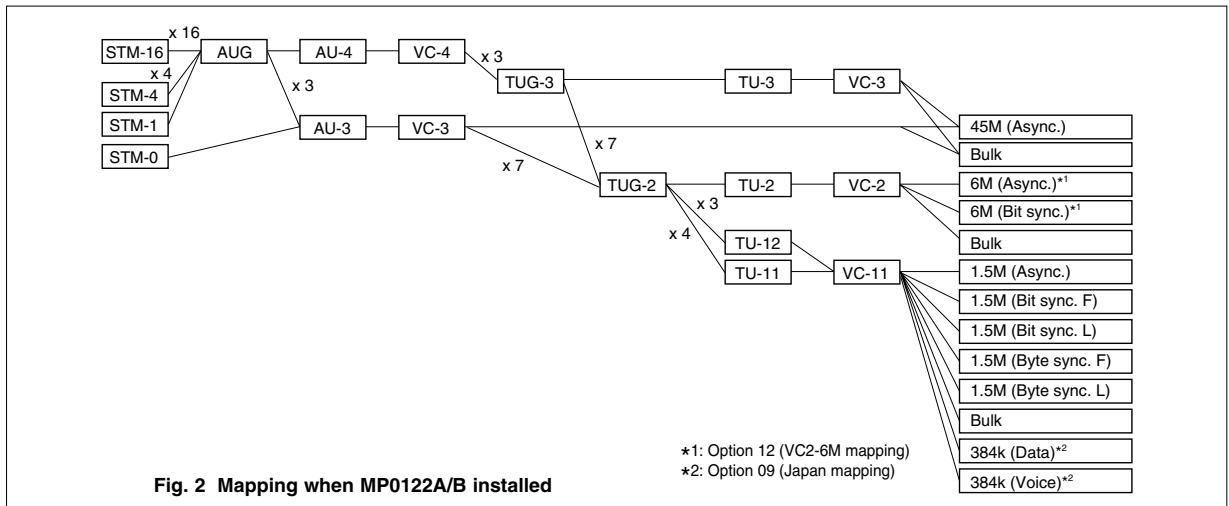
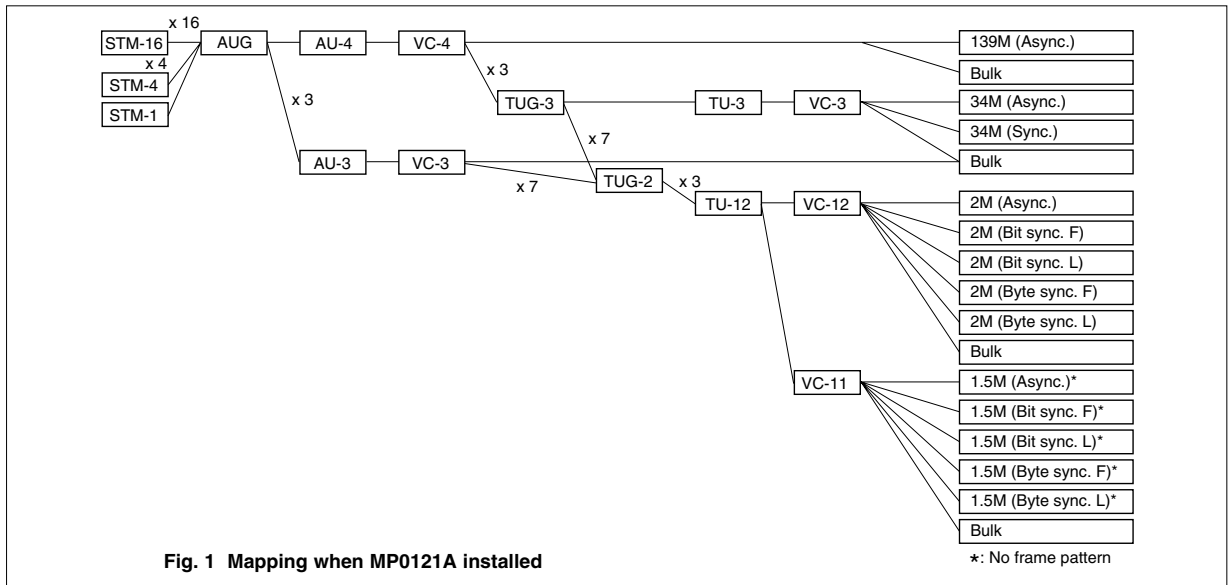

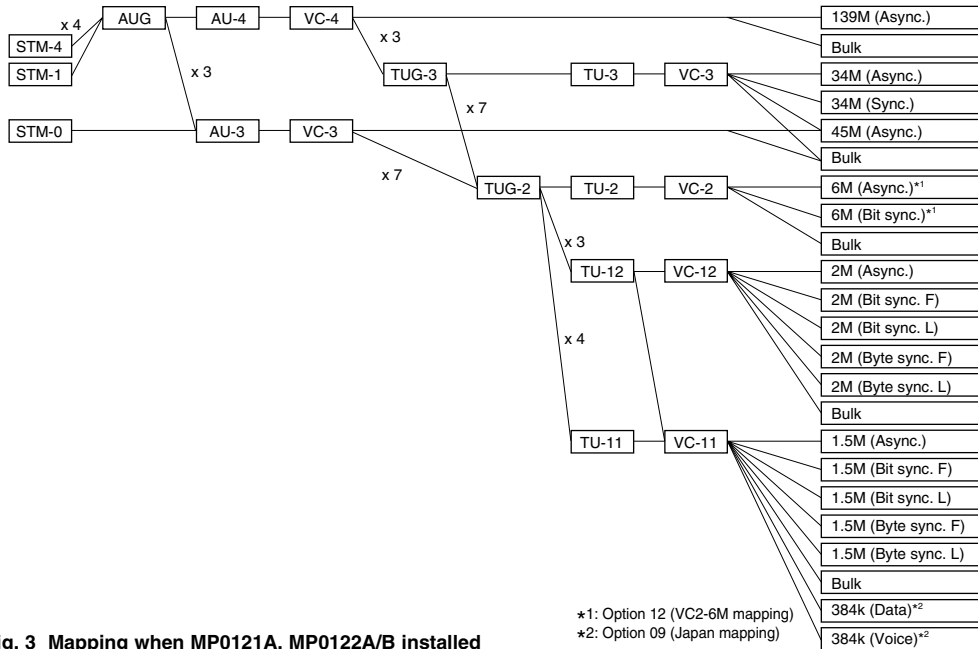

Fig. 3 Mapping when MP0121A, MP0122A/B installed

• **MP0124A/0125A/0126A Jitter Unit**

Bit rate	MP0124A: 2.048, 8.448, 34.368, 139.264, 155.520, 622.080 Mb/s MP0125A: 1.544, 44.736, 51.840, 155.520, 622.080 Mb/s MP0126A: 1.544, 2.048, 8.448, 34.368, 44.736, 139.264, 51.840, 155.520, 622.080 Mb/s																																																																																										
Jitter generation	<p>Modulation frequency: 0.1 Hz to 6 MHz Amplitude: 0 to 202.0 Ulp-p Resolution: 0.001 Ulp-p (2 UI range), 0.01 Ulp-p (20 UI range), 0.1 Ulp-p (50/200 UI range)</p> <table border="1"> <thead> <tr> <th>Bit rate (Mb/s)</th> <th>F1 (Hz)</th> <th>F1' (Hz)</th> <th>F2* (kHz)</th> <th>F2'* (kHz)</th> <th>F3* (kHz)</th> <th>F4* (kHz)</th> <th>F5* (kHz)</th> <th>F6* (kHz)</th> </tr> </thead> <tbody> <tr> <td>1.544</td> <td>0.1</td> <td>-</td> <td>0.5</td> <td>-</td> <td>10</td> <td>12.5</td> <td>50</td> <td>-</td> </tr> <tr> <td>2.048</td> <td>0.1</td> <td>-</td> <td>1</td> <td>-</td> <td>20</td> <td>27.5</td> <td>110</td> <td>-</td> </tr> <tr> <td>8.448</td> <td>0.1</td> <td>-</td> <td>2</td> <td>-</td> <td>20</td> <td>105</td> <td>420</td> <td>-</td> </tr> <tr> <td>34.368</td> <td>0.1</td> <td>-</td> <td>5</td> <td>-</td> <td>100</td> <td>250</td> <td>1000</td> <td>-</td> </tr> <tr> <td>44.736</td> <td>0.1</td> <td>-</td> <td>5</td> <td>-</td> <td>100</td> <td>250</td> <td>1000</td> <td>-</td> </tr> <tr> <td>139.264</td> <td>0.1</td> <td>-</td> <td>5</td> <td>-</td> <td>100</td> <td>1000</td> <td>4000</td> <td>-</td> </tr> <tr> <td>51.840</td> <td>0.1</td> <td>-</td> <td>2</td> <td>-</td> <td>80</td> <td>50</td> <td>-</td> <td>500</td> </tr> <tr> <td>155.520</td> <td>0.1</td> <td>1000</td> <td>6.5</td> <td>25</td> <td>500</td> <td>150</td> <td>-</td> <td>1500</td> </tr> <tr> <td>622.080</td> <td>0.1</td> <td>500</td> <td>25</td> <td>50</td> <td>500</td> <td>600</td> <td>-</td> <td>6000</td> </tr> </tbody> </table> <p>*: typical value Accuracy: $\pm 5\% \pm 0.05$ Ulp-p at Fr (2 UI range), $\pm 5\% \pm 0.3$ Ulp-p at Fr (20 UI range), $\pm 5\% \pm 0.8$ Ulp-p at Fr (50 UI range), $\pm 5\% \pm 3.2$ Ulp-p at Fr (200 UI range) *Fr: 100 kHz (156M/622M, 2UI range), 500 Hz (1.5M, 20UI range), 1 kHz (others)</p>	Bit rate (Mb/s)	F1 (Hz)	F1' (Hz)	F2* (kHz)	F2'* (kHz)	F3* (kHz)	F4* (kHz)	F5* (kHz)	F6* (kHz)	1.544	0.1	-	0.5	-	10	12.5	50	-	2.048	0.1	-	1	-	20	27.5	110	-	8.448	0.1	-	2	-	20	105	420	-	34.368	0.1	-	5	-	100	250	1000	-	44.736	0.1	-	5	-	100	250	1000	-	139.264	0.1	-	5	-	100	1000	4000	-	51.840	0.1	-	2	-	80	50	-	500	155.520	0.1	1000	6.5	25	500	150	-	1500	622.080	0.1	500	25	50	500	600	-	6000
Bit rate (Mb/s)	F1 (Hz)	F1' (Hz)	F2* (kHz)	F2'* (kHz)	F3* (kHz)	F4* (kHz)	F5* (kHz)	F6* (kHz)																																																																																			
1.544	0.1	-	0.5	-	10	12.5	50	-																																																																																			
2.048	0.1	-	1	-	20	27.5	110	-																																																																																			
8.448	0.1	-	2	-	20	105	420	-																																																																																			
34.368	0.1	-	5	-	100	250	1000	-																																																																																			
44.736	0.1	-	5	-	100	250	1000	-																																																																																			
139.264	0.1	-	5	-	100	1000	4000	-																																																																																			
51.840	0.1	-	2	-	80	50	-	500																																																																																			
155.520	0.1	1000	6.5	25	500	150	-	1500																																																																																			
622.080	0.1	500	25	50	500	600	-	6000																																																																																			
Jitter tolerance measurement	Conforms to ITU-T G.823/G.824/G.825/G.958 Display: Numeric, graphic																																																																																										
Frequency offset	Range: ± 999.9 ppm/step (0.1 ppm, Jitter: off), ± 70 ppm/step (0.1 ppm, Jitter: on/off) Accuracy: ± 0.1 ppm (after power-on, calibrates after 60 min. warm-up, 23° $\pm 5^\circ$ C)																																																																																										
Auxiliary interface	External modulation input, external 10 MHz reference input, reference clock output																																																																																										

Continued on next page

Modulation frequency: 2 Hz to 5 MHz
 Amplitude: 0 to 20.00 Ulp-p, 0 to 7.07 Ulrms (Option 01)
 Resolution: 0.001 Ulp-p/0.001 Ulrms (2 UI range), 0.01 Ulp-p/0.01 Ulrms (20 UI range)

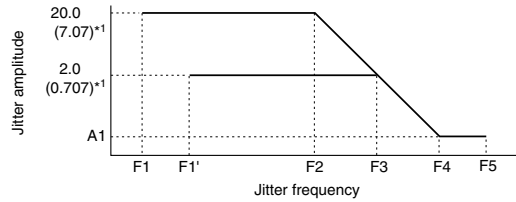

Bit rate (Mb/s)	A1 (Ulp-p)	F1 (Hz)	F1' (Hz)	F2 (kHz)	F3 (kHz)	F4 (kHz)	F5 (kHz)
1.544	0.5	2	20	0.2	2.5	10	40/(15) ^{*2}
2.048	0.5	2	20	0.45	6	25	100/(18) ^{*2}
8.448	0.5	2	20	0.2	10	100	400/(70) ^{*2}
34.368	0.5	2	20	0.5	40	500	800/(300) ^{*2}
44.736	0.5	2	20	3	40	200	400
139.264	0.5	2	20	0.25	50	1000	3500/(1200) ^{*2}
51.840	0.2	2	20	0.2	5	100	400
155.520	0.2	2	20	0.7	20	500	1300
622.080	0.2	2	20	20	200	2000	5000

*1: rms; F1, F1' = 100 Hz *2: 20 UI range in parentheses

Accuracy

[Ulp-p]: ±5% ±W Ulp-p (Fr Hz)

156 Mb/s (optical): When input level -25 dBm max. add 0.01 Ulp-p/dB to above specifications.

622 Mb/s (optical): When input level -20 dBm max. add 0.01 Ulp-p/dB to above specifications.

[Ulrms]: ±5% ±Y Ulrms (Fr Hz)

156 Mb/s (optical): When input level -25 dBm max. add 0.002 Ulrms/dB to above specifications.

622 Mb/s (optical): When input level -20 dBm max. add 0.002 Ulrms/dB to above specifications.

Frequency response (Fr Hz):

±5% (2 to 20 Hz), ±2% (20 Hz to 300 kHz), ±3% (300 kHz to 1 MHz), ±5% (1 to 3 MHz), ±10% (3 to 5 MHz)

*fr: 100 kHz (156M/622M, 2 UI range), 1 kHz (others)

Bit rate (Mb/s)	W (Ulp-p) ^{*1}		Y (Ulrms) ^{*2}	
	2 UI	20 UI	2 UI	20 UI
1.544 (CLK)	0.015	0.20	0.005	0.03
1.544 (AMI/B8ZS)	0.040	0.22	0.006	0.04
2.048 (CLK)	0.015	0.20	0.005	0.03
2.048 (HDB3)	0.040	0.22	0.006	0.04
8.448 (CLK)	0.015	0.20	0.005	0.03
8.448 (HDB3)	0.040	0.22	0.006	0.04
34.368 (CLK)	0.015	0.20	0.005	0.03
34.368 (HDB3)	0.040	0.22	0.017	0.04
44.736 (CLK)	0.015	0.20	0.005	0.03
44.736 (B3ZS)	0.040	0.22	0.006	0.04
139.264 (CLK)	0.030	0.20	0.005	0.03
139.264 (CMI)	0.040	0.30	0.022	0.06
51.840 (CLK)	0.015	0.20	0.005	0.03
51.840 (B3ZS)	0.040	0.22	0.017	0.05
51.840 (optical) ^{*3}	0.070	0.30	0.022	0.06
155.52 (CLK)	0.035	0.20	0.017	0.05
155.52 (CMI)	0.070	0.30	0.022	0.06
155.52 (optical) ^{*3}	0.070	0.30	0.022	0.06
622.08 (CLK)	0.050	0.20	0.027	0.07
622.08 (optical) ^{*3}	0.100	0.30	0.032	0.08

*1: With HP1 + LP, *2: With HP + LP, *3: +10° to +40°C

Filter

Bit rate (Mb/s)	HP0 (Hz)	HP1 (Hz)	HP2 (kHz)	HP2' (kHz)	HP (kHz)	LP (kHz)
1.544	10	10	8	-	12	40
2.048	10	20	18	0.7	12	100
8.448	10	20	3	80	12	400
34.368	10	100	10	-	12	800
44.736	10	10	30	-	12	400
139.264	10	200	10	-	12	3500
51.840	10	100	20	-	12	400
155.520	10	500	65	-	12	1300
622.080	10	1000	250	-	12	5000

Jitter measurement

Continued on next page

Hit measurement	Count, seconds, % free seconds																																																																																																													
Jitter transfer measurement	Conforms to ITU-T G.823/G.824/G.958 [selective bandwidth: ≤ 10 Hz (modulation frequency: ≥ 20 Hz)] Display: Numeric, graphic																																																																																																													
Frequency measurement	Resolution: 0.1 ppm, Display: Hz or ppm (after power-on, calibrates after 60 min. warm-up, 23' $\pm 5^\circ\text{C}$)																																																																																																													
Auxiliary interface	Demodulation output, reference clock input																																																																																																													
Wander generation	<p>Modulation frequency: 10 μHz to 0.2 Hz (sine wave)</p> <table border="1"> <thead> <tr> <th rowspan="2">Bit rate (Mb/s)</th> <th colspan="3">Amplitude</th> <th colspan="6">Frequency</th> </tr> <tr> <th>A0 (Ulp-p)</th> <th>A1 (Ulp-p)</th> <th>A2 (Ulp-p)</th> <th>f0 (μHz)</th> <th>f1 (μHz)</th> <th>f2 (mHz)</th> <th>f3 (mHz)</th> <th>f4 (mHz)</th> <th>f5 (mHz)</th> </tr> </thead> <tbody> <tr> <td>1.544</td> <td>40</td> <td>–</td> <td>20</td> <td>10</td> <td>–</td> <td>–</td> <td>65</td> <td>130</td> <td>200</td> </tr> <tr> <td>2.048</td> <td>40</td> <td>–</td> <td>20</td> <td>10</td> <td>–</td> <td>–</td> <td>65</td> <td>130</td> <td>200</td> </tr> <tr> <td>8.448</td> <td>200</td> <td>–</td> <td>20</td> <td>10</td> <td>–</td> <td>–</td> <td>13</td> <td>130</td> <td>200</td> </tr> <tr> <td>34.368</td> <td>1000</td> <td>113</td> <td>20</td> <td>10</td> <td>180</td> <td>1.6</td> <td>23</td> <td>130</td> <td>200</td> </tr> <tr> <td>44.736</td> <td>1200</td> <td>135</td> <td>20</td> <td>10</td> <td>180</td> <td>1.6</td> <td>19</td> <td>130</td> <td>200</td> </tr> <tr> <td>139.264</td> <td>3000</td> <td>338</td> <td>50</td> <td>10</td> <td>180</td> <td>1.6</td> <td>19</td> <td>130</td> <td>200</td> </tr> <tr> <td>51.840</td> <td>1200</td> <td>135</td> <td>20</td> <td>10</td> <td>180</td> <td>1.6</td> <td>19</td> <td>130</td> <td>200</td> </tr> <tr> <td>155.520</td> <td>3600</td> <td>406</td> <td>50</td> <td>10</td> <td>180</td> <td>1.6</td> <td>16</td> <td>130</td> <td>200</td> </tr> <tr> <td>622.080</td> <td>14400</td> <td>1620</td> <td>200</td> <td>10</td> <td>180</td> <td>1.6</td> <td>16</td> <td>130</td> <td>200</td> </tr> </tbody> </table>	Bit rate (Mb/s)	Amplitude			Frequency						A0 (Ulp-p)	A1 (Ulp-p)	A2 (Ulp-p)	f0 (μHz)	f1 (μHz)	f2 (mHz)	f3 (mHz)	f4 (mHz)	f5 (mHz)	1.544	40	–	20	10	–	–	65	130	200	2.048	40	–	20	10	–	–	65	130	200	8.448	200	–	20	10	–	–	13	130	200	34.368	1000	113	20	10	180	1.6	23	130	200	44.736	1200	135	20	10	180	1.6	19	130	200	139.264	3000	338	50	10	180	1.6	19	130	200	51.840	1200	135	20	10	180	1.6	19	130	200	155.520	3600	406	50	10	180	1.6	16	130	200	622.080	14400	1620	200	10	180	1.6	16	130	200
Bit rate (Mb/s)	Amplitude			Frequency																																																																																																										
	A0 (Ulp-p)	A1 (Ulp-p)	A2 (Ulp-p)	f0 (μHz)	f1 (μHz)	f2 (mHz)	f3 (mHz)	f4 (mHz)	f5 (mHz)																																																																																																					
1.544	40	–	20	10	–	–	65	130	200																																																																																																					
2.048	40	–	20	10	–	–	65	130	200																																																																																																					
8.448	200	–	20	10	–	–	13	130	200																																																																																																					
34.368	1000	113	20	10	180	1.6	23	130	200																																																																																																					
44.736	1200	135	20	10	180	1.6	19	130	200																																																																																																					
139.264	3000	338	50	10	180	1.6	19	130	200																																																																																																					
51.840	1200	135	20	10	180	1.6	19	130	200																																																																																																					
155.520	3600	406	50	10	180	1.6	16	130	200																																																																																																					
622.080	14400	1620	200	10	180	1.6	16	130	200																																																																																																					
Wander measurement (Option 02)	<p>Reference input: 1.544M (AMI/B8ZS, clock), 2.048M (HDB3, clock)</p> <p>Measurement range p-p: 0.0 to 3.2E5 ns, +p/-p: 0.0 to 1.6E5 ns, TIE: ± 0.0 to 1.6E5 ns, MTIE*: 0.0 to 1E6 ns, TDEV*: 0.0 to 1E6 ns *: MTIE, TDEV measurement require external PC and MX150001A Wander (MTIE, TDEV) Application Software</p> <p>Resolution: 0.1 ns Sampling interval: 25 ms Filter: DC to 0.01 Hz, DC to 10 Hz, 0.01 Hz to 10 Hz Display: Numeric, graphic</p>																																																																																																													

• MP0130A 2.5G Jitter Unit

Jitter generation	<p>Frequency: 2488.32 MHz Modulation frequency: 0.1 Hz to 20 MHz Amplitude: 0 to 808.0 Ulp-p</p> <table border="1"> <thead> <tr> <th>Bit rate</th> <th>F1 (Hz)</th> <th>F1' (Hz)</th> <th>F2 (Hz)</th> <th>F2' (Hz)</th> <th>F3 (kHz)</th> <th>F4 (kHz)</th> <th>F5 (Hz)</th> </tr> </thead> <tbody> <tr> <td>2488.32 Mb/s</td> <td>0.1</td> <td>15</td> <td>600</td> <td>25</td> <td>500</td> <td>2,000</td> <td>20,000</td> </tr> </tbody> </table>	Bit rate	F1 (Hz)	F1' (Hz)	F2 (Hz)	F2' (Hz)	F3 (kHz)	F4 (kHz)	F5 (Hz)	2488.32 Mb/s	0.1	15	600	25	500	2,000	20,000
Bit rate	F1 (Hz)	F1' (Hz)	F2 (Hz)	F2' (Hz)	F3 (kHz)	F4 (kHz)	F5 (Hz)										
2488.32 Mb/s	0.1	15	600	25	500	2,000	20,000										
Jitter tolerance measurement	ITU-T G.825, G.958A, G.958B, user, Bellcore 253																
Frequency offset	± 70 ppm/step (0.1 ppm, jitter: on/off)																
Auxiliary interface	External clock input, reference clock output																

Continued on next page

Jitter measurement	<p>Frequency: 2488.32 MHz \pm50 ppm</p> <table border="1"> <thead> <tr> <th>Bit rate</th> <th></th> <th>F0 (Hz)</th> <th>F0' (Hz)</th> <th>F2 (kHz)</th> <th>F2' (kHz)</th> <th>F3 (kHz)</th> <th>F4 (Hz)</th> </tr> </thead> <tbody> <tr> <td rowspan="2">2488.32 Mb/s</td> <td>2 UI</td> <td>–</td> <td>100</td> <td>–</td> <td>100</td> <td>1,000</td> <td>20,000</td> </tr> <tr> <td>32 UI</td> <td>10</td> <td>–</td> <td>6.25</td> <td>–</td> <td>1,000</td> <td>20,000</td> </tr> </tbody> </table>	Bit rate		F0 (Hz)	F0' (Hz)	F2 (kHz)	F2' (kHz)	F3 (kHz)	F4 (Hz)	2488.32 Mb/s	2 UI	–	100	–	100	1,000	20,000	32 UI	10	–	6.25	–	1,000	20,000						
Bit rate		F0 (Hz)	F0' (Hz)	F2 (kHz)	F2' (kHz)	F3 (kHz)	F4 (Hz)																							
2488.32 Mb/s	2 UI	–	100	–	100	1,000	20,000																							
	32 UI	10	–	6.25	–	1,000	20,000																							
Jitter transfer measurement	ITU-T G.958A, G.958B, user, Bellcore 253 [selectable bandwidth: \leq 10 Hz (modulation frequency: \geq 20 Hz)]																													
Frequency measurement	2488.32 MHz \pm 100 ppm (resolution: 0.1 ppm)																													
Hit measurement	Count, seconds, % free seconds																													
Auxiliary interface	Reference, clock input																													
Wander generator	<p>Frequency: 2488.32 MHz Modulation frequency: 10 μHz to 200 mHz (sine wave)</p> <table border="1"> <thead> <tr> <th rowspan="2">Bit rate</th> <th colspan="3">Amplitude (UIp-p)</th> <th colspan="6">Frequency (mHz)</th> </tr> <tr> <th>A0</th> <th>A1</th> <th>A2</th> <th>f0</th> <th>f1</th> <th>f2</th> <th>f3</th> <th>f4</th> <th>f5</th> </tr> </thead> <tbody> <tr> <td>2488M</td> <td>57,600</td> <td>6,480</td> <td>800</td> <td>0.01</td> <td>0.18</td> <td>1.6</td> <td>16</td> <td>130</td> <td>200</td> </tr> </tbody> </table>	Bit rate	Amplitude (UIp-p)			Frequency (mHz)						A0	A1	A2	f0	f1	f2	f3	f4	f5	2488M	57,600	6,480	800	0.01	0.18	1.6	16	130	200
Bit rate	Amplitude (UIp-p)			Frequency (mHz)																										
	A0	A1	A2	f0	f1	f2	f3	f4	f5																					
2488M	57,600	6,480	800	0.01	0.18	1.6	16	130	200																					
Wander measurement	<p>Frequency: 2488.32 MHz \pm50 ppm (Wander measurement becomes effective when MP0124A/0125A/0126A plus Option 02 is mounted.) Measurement frequency: Up to 10 Hz Measurement range P-P: 0.0 to 3.2E5 ns, +P/-P: 0.0 to 1.6E5 ns, TIE: 0.0 to \pm1.6E5 ns, MTIE/TDEV: 0.0 to 1.0E6 ns Auto-measurement: TIE, MTIE, TDEV (MTIE, TDEV: necessary for MX150001A application software)</p>																													

• MP0123A ATM Unit

Bit rate	1.544, 2.048, 34.368, 44.736, 139.364, 51.840, 155.520, 622.080 Mb/s
Mapping	
Traffic pattern	CBR, burst, sawtooth, PCR with CBR, Poisson
Test patterns	<p>Cell: Single cell PRBS 9, cross cell PRBS 9/15/23, 16-bit word pattern, edit pattern, time stamp O.191: Edit pattern AAL1: Single cell PRBS 9, cross cell PRBS 9/15/23, 16-bit word pattern, edit pattern, time stamp AAL2 (CPS-PDU): Time stamp AAL2 (CPS-PACKET): Single cell PRBS 7, 8-bit word pattern, edit pattern AAL3/4 (SAR-PDU): Time stamp AAL3/4 (CPCS-PDU): Single cell PRBS 9, cross cell PRBS 9/15/23, 16-bit word pattern, edit pattern AAL5: Single cell PRBS 9, cross cell PRBS 9/15/23, 16-bit word pattern, edit pattern</p>

Continued on next page

Error addition	Cell: HEC, programmable pattern O.191: Lost cell, misinserted cell, errored cell, SECB AAL1: Lost cell, SNP, PRBS, word AAL2 (CPS-PDU): P, SN, OSF AAL2 (CPS-PACKET): HEC, PRBS, word AAL3/4 (SAR-PDU): SN, CRC10, segment type, LI, abort AAL3/4 (CPCS-PDU): CPI, B/E tag mismatch, BA size, AL, length, PRBS, word AAL5: Frame size, length, CRC32, abort, PRBS, word
Alarm addition	LCD, VP/VC AIS, VP/VC RDI, VP/VC CC, VP/VC loopback cell
PM cell	Error insertion: Lost cell, misinserted cell, BIPV, SECB
Cell editing	O.191, AAL1, AAL2, AAL3/4, AAL5, AIS, RDI, CC, loopback, FM, BR, background (10 ch)
Memorized cell	Possible to send after editing receiver's capture data
Measurement	Mode: Single, repeat, manual Error Cell: Cell count, correctable HEC, uncorrectable HEC, non-conforming cell O.191: Errored cell, lost cell, misinserted cell, SECB AAL1: SAR-PDU count, lost cell, SNP, uncorrectable SNP, PRBS, word AAL2: CPS-PDU count, P, OSF, SN, CPS packet count, HEC, PRBS, word AAL3/4*: SAR-PDU count, CRC10, MID count (SAR-PDU with selected MID value), SN, ST (segment type), LI, abort, discarded PDU (one of SN error, LI error, abort, COM with ST error, or EOM with ST error), CPCS-PDU count, CPI, B/E tag mismatch, BA size, AL, length, undelivered PDU (one of CPI error, B/E tag mismatch, BA size error, AL error, or length error), PRBS, word *CRC10 is calculated for all SAR-PDU. The others are calculated for SAR-PDU with specified MID. AAL5: CPCS-PDU count, frame size, length, CRC32, abort, discarded PDU (one of frame size error, length error, CRC32 error, or abort), PRBS, word FM: Lost cell, misinserted cell, BIPV, SECB BR: Lost cell, misinserted cell, BIPV, SECB Alarm: LCD, VP/VC segment AIS, VP/VC end-to-end AIS, VP/VC segment RDI, VP/VC end-to-end RDI, VP/VC segment LOC, VP/VC end-to-end LOC
LED	LCD, VP-AIS, VP-RDI, VP-LOC, VC-AIS, VC-RDI, VC-LOC, error
Monitor	Live monitor (1023 channel monitor), traffic monitor, cell monitor
Delay measurement	1-point CDV, 2-point CDV
Capture	1 to 2016 cells

• MP0131A Add/Drop Unit

Bit rate	1.544, 2.048, 34.368, 44.736, 139.264 Mb/s
Level/waveform	1.544 Mb/s: ANSI T1.102, 0/655 ft 44.736 Mb/s: ANSI T1.102, 0/450/900 ft (0 ft: Drop only) 2.048/34.368/139 Mb/s: ITU-T G.703
Connector	BANTAM (100 Ω, balanced): 1.544 Mb/s (AMI/B8ZS) 3-pin Siemens (120 Ω, balanced): 2.048 Mb/s (HDB3) BNC (75 Ω, unbalanced): 2.048 Mb/s, 34.368 Mb/s (HDB3), 139.264 Mb/s (CMI)
Mapping	Fig-4

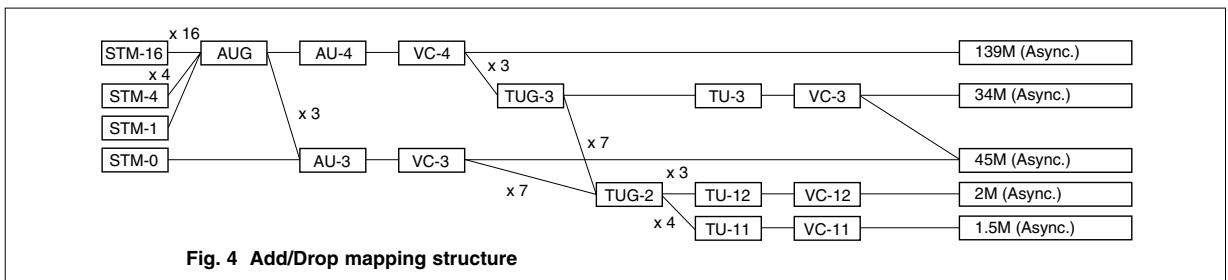

● MP0111A Optical 156M/622M (1.31) Unit

Transmit	Bit rate: 155.520, 622.080 Mb/s (NRZ) Wavelength: 1310 nm Output level: -11.5 dBm ±3.5 dB Optical safety: IEC 825-1 Class 1, 21CFR1040.10 Class I Connector: FC-PC (SM-F)
Receive	Bit rate: 155.520, 622.080 Mb/s (NRZ) Sensitivity 156M: -33 to -8 dBm (test pattern: PRBS 2 ²³ - 1, BER 10 ⁻¹⁰ , +10° to +40°C) 622M: -28 to -8 dBm (test pattern: PRBS 2 ²³ - 1, BER 10 ⁻¹⁰ , +10° to +40°C) Connector: FC-PC (SM-F) Power measurement Measurement range: -30 to 0 dBm (peak power) Accuracy: ≤±1 dB (-20 dBm) Linearity: ≤±1 dB (-30 to 0 dBm)

● MP0112A Optical 156M/622M (1.55) Unit

Transmit	Bit rate: 155.520, 622.080 Mb/s (NRZ) Wavelength: 1550 nm Output level: -5 dBm ±2 dB Optical safety: IEC825-1 Class 1, 21CFR1040.10 Class I Connector: FC-PC (SM-F)
Receive	Bit rate: 155.520, 622.080 Mb/s (NRZ) Sensitivity 156M: -33 to -8 dBm (test pattern: PRBS 2 ²³ - 1, BER 10 ⁻¹⁰ , +10° to +40°C) 622M: -28 to -8 dBm (test pattern: PRBS 2 ²³ - 1, BER 10 ⁻¹⁰ , +10° to +40°C) Connector: FC-PC (SM-F) Power measurement Measurement range: -30 to 0 dBm (peak power) Accuracy: ≤±1 dB (-20 dBm) Linearity: ≤±1 dB (-30 to 0 dBm)

● MP0113A Optical 156M/622M (1.31/1.55) Unit

Transmit	Bit rate: 155.520, 622.080 Mb/s (NRZ) Wavelength: 1310/1550 nm Output level 1.31 μm: -11.5 dBm ±3.5 dB, 1.55 μm: -5 dBm ±2 dB Optical safety: IEC825-1 Class 1, 21CFR1040.10 Class I Connector: FC-PC (SM-F)
Receive	Bit rate: 155.520, 622.080 Mb/s (NRZ) Sensitivity 156M: -33 to -8 dBm (test pattern: PRBS 2 ²³ - 1, BER 10 ⁻¹⁰ , +10° to +40°C) 622M: -28 to -8 dBm (test pattern: PRBS 2 ²³ - 1, BER 10 ⁻¹⁰ , +10° to +40°C) Connector: FC-PC (SM-F) Power measurement Measurement range: -30 to 0 dBm (peak power) Accuracy: ≤±1 dB (-20 dBm) Linearity: ≤±1 dB (-30 to 0 dBm)

● MP0105A CMI Unit

Transmit	Bit rate: 155.520 Mb/s, Level: 1 ±0.1 V, Connector: BNC (75 Ω)
Receive	Bit rate: 155.520 Mb/s Level: 1 ±0.1 V (0 to 12 dB, with √f auto correction and monitor function) Connector: BNC (75 Ω)

● MP0108A NRZ Unit

Transmit	Bit rate: 155.520, 622.080 Mb/s Level: ECL Connector (clock, data): SMA (50 Ω)
Receive	Bit rate: 155.520, 622.080 Mb/s Level: ECL (-2 V) Connector (clock, data): SMA (50 Ω)

● MP0122B 1.5/45/52/52 (1.31) Unit Optical interface

Transmit	Bit rate: 51.84 Mb/s (NRZ) Wavelength: 1310 nm Output level: -11.5 dBm ±3.5 dB Optical safety: IEC 825-1 Class 1, 21CFR1040.10 Class I Connector: FC-PC (SM-F)
Receive	Bit rate: 51.84 Mb/s (NRZ) Sensitivity 52M: -33 to -8 dBm (test pattern: PRBS 2 ²³ - 1, BER 10 ⁻¹⁰ , +10° to +40°C) Connector: FC-PC (SM-F) Power measurement Measurement range: -30 to 0 dBm (peak power) Accuracy: ≤±1 dB (-20 dBm) Linearity: ≤±1 dB (-30 to 0 dBm) Monitor input Level: 0.1 to 1.0 Vp-p (AC), Connector: SMA (50 Ω)

● MP0127A/0128A/0129A 2.5G Unit

Bit rate	2488.32 Mb/s (NRZ)
Optical output	Wavelength: 1310 nm (MP0127A), 1550 nm (MP0128A), 1310/1550 nm (MP0129A) Output level: -4 dBm ±3 dB Optical safety: IEC825-1 Class 3A, 21CFR1040.10 Class IIIb Connector: FC-PC (SM-F)
Optical input	Sensitivity Narrow: -28 to -9 dBm (BER 10 ⁻¹⁰ , +10° to +30°C), Wide: -20 to -9 dBm (BER 10 ⁻¹⁰ , +10° to +40°C) Connector: FC-PC (SM-F) Power measurement Range: -30 to -9 dBm (peak power) Accuracy: ≤±2 dB (-20 dBm) Linearity: ≤±2 dB (-30 to -9 dBm)
Electrical I/O	Transmit (NRZ) Level: ECL (-2 V), Connector (data, clock): SMA (50 Ω) Receive (NRZ) Level: ECL (-2 V), Connector (data, clock): SMA (50 Ω) Monitor input Level: 0.1 to 1.0 Vp-p (AC), Connector (data): SMA (50 Ω)
Auxiliary interface	External clock input, receive clock output, sync. output
Others	Non-frame pattern, PRBS: 2 ²³ - 1, (0.151)*

*: Option 02 (MP0127A/0128A/0129A-02)

Ordering information

Please specify model/order number, name, and quantity when ordering.

Model/Order No.	Name
MP1552B	Main frame SDH/PDH/ATM Analyzer
	Standard accessories
J0670A	AC power cord: 1 pc
Z0169	Printer paper (5 rolls/pack): 1 pack
F0014	Fuse, 6.3 A: 2 pcs
B0329G	Protective cover: 1 pc
J0907Q	Remote interlock cord (for MP0127A/0128A/0129A): 1 pc
J0908	Remote interlock terminator (for MP0127A/0128A/0129A): 1 pc
E0008A	Optical output control key (for MP0127A/0128A/0129A): 1 pc
J0747C	Fixed optical attenuator (for MP0127A/0128A/0129A): 1 pc
J0900A	Coaxial cable (AA-165-200), 20 cm (for MP0130A): 2 pcs
W1503AE	MP1552B operation manual (Vol. 1, Panel operation): 1 copy
W1504AE	MP1552B operation manual (Vol. 2, Remote control, supplied with MP1552B-01 or MP1552B-02): 1 copy
W1505AE	MP1552B operation manual (Vol. 3, Jitter/wander, supplied with MP0124A, MP0125A or MP0126A): 1 copy
W1506AE	MP1552B operation manual (Vol. 4, ATM, supplied with MP0123A): 1 copy
W1507AE	MP1552B operation manual (Vol. 5: 2.5G, supplied with MP0127A/0128A/0129A): 1 copy
W1508AE	MP1552B operation manual (Vol. 6: 2.5G jitter, supplied with MP0130A): 1 copy
W1509AE	MP1552B operation manual (Vol. 7: Add/Drop, supplied with MP0131A): 1 copy
W1323AE	MX150001A wander (MTIE, TDEV) application software operation manual (supplied with MX150001A): 1 copy
	Plug-in units
MP0121A*1	2/8/34/139/156M Unit
MP0122A*1	1.5/45/52M Unit
MP0122B*1	1.5/45/52/52M (1.31) Unit
MP0123A	ATM Unit
MP0124A	2/8/34/139M, 156/622M Jitter Unit (only jitter generation/measurement, requires MP0121A)
MP0125A	1.5/45/52M, 156/622M Jitter Unit (only jitter generation/measurement, requires MP0122A/B)
MP0126A	2/8/34/139M, 1.5/45/52M, 156/622M Jitter Unit (only jitter generation/measurement, requires MP0121A or MP0122A/B)
MP0127A*2	2.5G (1.31) Unit (with optical power meter)
MP0128A*2	2.5G (1.55) Unit (with optical power meter)
MP0129A*2	2.5G (1.31/1.55) Unit (with optical power meter)
MP0130A	2.5G Jitter Unit
MP0131A	Add/Drop Unit
MP0111A*2,*3	Optical 156M/622M (1.31) Unit (with optical power meter)
MP0112A*2,*3	Optical 156M/622M (1.55) Unit (with optical power meter)
MP0113A*2,*3	Optical 156M/622M (1.33/1.55) Unit (with optical power meter, 1.31/1.55 switchable)
MP0105A	CMI Unit (used in common with MP1550A/B)
MP0108A	NRZ Unit (used in common with MP1550A/B)
	Options
MP1552B-01	RS-232C
MP1552B-02	GPIB
MP1552B-03	Ethernet
MP1552B-05*4	SDH/SONET
MP1552B-06	MUX/DEMUX (2/8/34/139 Mb/s, for MP0121A)
MP1552B-07	MUX/DEMUX (1.5/45 Mb/s, for MP0122A/B)
MP1552B-08	45M-2M MUX/DEMUX (requires MP0121A and MP0122A/B)
MP1552B-09	VC11-384k mapping (for MP0122A/B)
MP1552B-12	VC2-6M mapping
MP1552B-15*5	Video output
MP1552B-16	64k lock
MP1552B-17	Japan ESF (requires MP0122A or MP0122B)
MP0124A-01	RMS measurement
MP0125A-01	RMS measurement
MP0126A-01	RMS measurement

Model/Order No.	Name
MP0130A-01	RMS measurement
MP0124A-02	Wander measurement
MP0125A-02	Wander measurement
MP0126A-02	Wander measurement
MP0127A-02	2.5G non-frame pattern (requires MP0122A or MP0122B)
MP0128A-02	2.5G non-frame pattern (requires MP0122A or MP0122B)
MP0129A-02	2.5G non-frame pattern (requires MP0122A or MP0122B)
MP0111A/0112A-37	FC connector (exchangeable 2 sets)
MP0111A/0112A-38	ST connector (exchangeable 2 sets)
MP0111A/0112A-39	DIN connector (exchangeable 2 sets)
MP0111A/0112A-40	SC connector (exchangeable 2 sets)
MP0111A/0112A-43	HMS-10/A connector (exchangeable 2 sets)
MP0113A-37	FC connector (exchangeable 3 sets)
MP0113A-38	ST connector (exchangeable 3 sets)
MP0113A-39	DIN connector (exchangeable 3 sets)
MP0113A-40	SC connector (exchangeable 3 sets)
MP0113A-43	HMS-10/A connector (exchangeable 3 sets)
MP0122B-37	FC connector (replaceable, 2 sets)
MP0122B-38	ST connector (replaceable, 2 sets)
MP0122B-39	DIN connector (replaceable, 2 sets)
MP0122B-40	SC connector (replaceable, 2 sets)
MP0122B-43	HMS-10/A connector (replaceable, 2 sets)
MP0127A-37	FC connector (replaceable, 2 sets)
MP0128A-37	FC connector (replaceable, 2 sets)
MP0129A-37	FC connector (replaceable, 2 sets)
MP0127A-38	ST connector (replaceable, 2 sets)
MP0128A-38	ST connector (replaceable, 2 sets)
MP0129A-38	ST connector (replaceable, 2 sets)
MP0127A-39	DIN connector (replaceable, 2 sets)
MP0128A-39	DIN connector (replaceable, 2 sets)
MP0129A-39	DIN connector (replaceable, 2 sets)
MP0127A-40	SC connector (replaceable, 2 sets)
MP0128A-40	SC connector (replaceable, 2 sets)
MP0129A-40	SC connector (replaceable, 2 sets)
MP0127A-43	HMS-10/A connector (replaceable, 2 sets)
MP0128A-43	HMS-10/A connector (replaceable, 2 sets)
MP0129A-43	HMS-10/A connector (replaceable, 2 sets)
	Application equipment
MP1656A	Portable STM-16 Analyzer
	Optional accessories
MX150001A	Wander (MTIE, TDEV) Measurement Application Software (for MP0124A/0125A/0126A-02)
J0796A	ST connector (exchangeable, with protective caps, 1 set)
J0796B	DIN connector (exchangeable, with protective caps, 1 set)
J0796C	SC connector (exchangeable, with protective caps, 1 set)
J0796D	HMS-10/A connector (exchangeable, with protective caps, 1 set)
J0796E	FC connector (exchangeable, with protective caps, 1 set)
J0162A	Balanced cable, 1 m (Siemens 3P-Siemens 3P)
J0162B	Balanced cable, 2 m (Siemens 3P-Siemens 3P)
J0845A	Balanced cable, 6 ft (BANTAM 3P/BANTAM 3P)
J0775D	Coaxial cable (BNC-P620 • 3C-2WS • BNC-P620, 75 Ω), 2 m
J0776D	Coaxial cable (BNC-P-3W • 3D-2W • BNC-P-3W, 50 Ω), 2 m
J0398A	Conversion cable (M-1PS • BANTAM 3P), 1 m
J0398B	Conversion cable (M-1PS • BANTAM 3P), 2 m
J0635A	Optical fiber cable, 1 m (SM, FC-SPC connector both ends)
J0635B	Optical fiber cable, 2 m (SM, FC-SPC connector both ends)
J0635C	Optical fiber cable, 3 m (SM, FC-SPC connector both ends)
J0747B	Fixed optical attenuator (10 dB, SM, FC-SPC connector both ends)
J0747C	Fixed optical attenuator (15 dB, SM, FC-SPC connector both ends)
J0747D	Fixed optical attenuator (20 dB, SM, FC-SPC connector both ends)
J0322B	Coaxial cable (11SMA • SUCOFLEX104 • 11SMA), 1 m
J0008	GPIB cable, 2 m
B0448	Soft case
B0336C	Carrying case

*1: Either the MP0121A or the MP0122A/B is required to operate the MP1552B.

*2: Specify the connector to be supplied as the standard connector when ordering the above options. If the connector is not specified, the FC connector (MP0111A/0112A/0113A/0122B/0127A/0128A/0129A-37) is supplied as standard.

*3: MP0111A/0112A/0113A can not be used with MP1550A/B.

*4: The SONET functions (technical terms) can be used with the MP1552B.

*5: The video output, RS-232C and GPIB options cannot all be used simultaneously. Only the video output + RS-232C, or video output + GPIB, or RS-232C + GPIB board combinations support simultaneous use, so change the board combinations according to the purpose.